



TeleLite 724 Series

CFJ and OEI Assemblies

TeleLite 724 Series Assemblies

Table of Contents

1.0	TeleLite CFJ/OEI Backboard and Cabinet Assemblies	2
1.1	Mounting.....	2
1.2	Grounding.....	2
1.2.1	CFJ:	2
1.2.2	OEI:.....	2
1.3	Fiber Installation	2
1.4	Power Installation	3
1.5	Installing Copper Entrance Cable in the Copper Fiber Junction (CFJ)	3
1.6	Installing Station Cable in the Optical Electrical Interface (OEI).....	5
1.7	Optical Modules	5
1.8	Copper Connections.....	5
1.9	Fiber Connections	6
2.0	TeleLite ZOI CFJ Cabinet Assemblies	6
2.1	Mounting.....	6
2.2	Grounding.....	7
2.3	Fiber Installation	7
2.4	Copper Entrance Cable	7
2.5	Optical Modules	8
2.6	Copper Connections.....	9
2.7	Fiber Connections	9
3.0	TeleLite Assembly Layout Drawings	10
4.0	Contact Information.....	20

1.0 TeleLite CFJ/OEI Backboard and Cabinet Assemblies

List of TeleLite hybrid fiber assemblies covered in this section:

724201/05	27" x 21" TeleLite OEI / CFJ Backboard Assembly with a single 6-slot shelf
724201/15	32" x 24" TeleLite OEI / CFJ Cabinet Assembly with a single 6-slot shelf
724211/05	37" x 29" TeleLite OEI / CFJ Backboard Assembly with a single 6-slot shelf
724211/15	40" x 32" TeleLite OEI / CFJ Cabinet Assembly with a single 6-slot shelf
724221/05	37" x 29" TeleLite OEI / CFJ Backboard Assembly with dual 6-slot shelves
724221/15	40" x 32" TeleLite OEI / CFJ Cabinet Assembly with dual 6-slot shelves

1.1 Mounting

- Mount TeleLite Cabinet onto "H"-Frame, Pole-mount fixture, or an interior wall.
 - 7550PK-24: Pole-Mount Kit for 724201/15
 - 7550PK-30: Pole-Mount Kit for 724211/15, 724221/15, 724200/15
- Mount TeleLite Backboard Assembly in either a suitable weather resistant cabinet, or onto an interior wall.

1.2 Grounding

1.2.1 CFJ:

Only if the TeleLite CFJ cabinet is located **at, or beyond, the 300 volt point** of the substation's GPR contour, connect local ground to assembly ground bar using a minimum 6 AWG conductor. If cabinet is placed within the ZOI of the substation **DO NOT** connect the ground, per IEEE-487.3. If a CFJ must be located in the ZOI of the substation, refer to the ZOI CFJ Section 2.0 of this document.

1.2.2 OEI:

Connect station-ground to ground bar on backboard of the TeleLite OEI.

1.3 Fiber Installation

Feed incoming fiber cable to the assembly backboard.

- If splicing of pigtails to the incoming fiber cable is required, use the provided Channell fiber splice case located on the TeleLite backboard to house the splice, using the fiber take-up spools to wind the excess fiber.
- If a pre-connectorized fiber cable is used, patch cords may be required. In this case, mount a fiber patch panel (Positron Model #'s 7200FO-SM or 7200FO-MM) onto the metal bracket provided, using the fiber take-up spools to wind the excess fiber.

1.4 Power Installation

The Positron TeleLite CFJ or OEI assemblies can be powered from either -48Vdc, 120Vac or 130Vdc, depending on site conditions. Feed the incoming power to the fused power input terminal block mounted on the assembly backboard. See Figure 1.

If a power supply is required, plug the TeleLite power supply into the left-most card slot of the TeleLite 6-slot shelf. Secure the power supply in the card-slot using the thumb screws on the TeleLite power supply faceplate.

Using the pre-installed, orange and yellow power conductors pre-wired to the drop-side of the Universal Input Terminal Block, route these power conductors from the drop-side of the fused power input terminal block to the power input terminals located on the faceplate of the TeleLite plug-in power supply or access card (Positron model #'s 720001, 721123, 721124 or 721125).

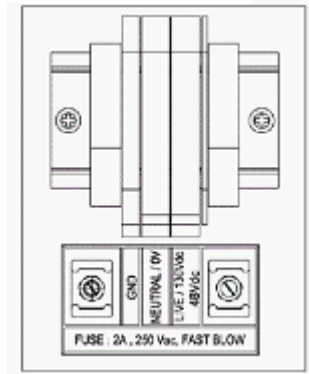

Fig. 1: Universal Power Input Terminal Block

1.5 Installing Copper Entrance Cable in the Copper Fiber Junction (CFJ)

1.5.1 Punch incoming copper pairs onto the right-hand side of the 25-pair solid state protector block. See Figure 2. The “Out” side of the protector block always “points” to the world outside of the HVI, be it in the substation (Control House) or in the network (PSTN). The pre-installed protector block is pre-connected to ground bar installed on the backboard. Refer to Section 1.2 for notes on grounding.

1.5.2 Equip the protector block with the solid state protectors as appropriate (Positron Model #'s 72505P-06 or 72505P-12, sold separately).

1.5.3 If required, install NCTE Mounting (aka NIU Housing/Chassis) on the backboard in the space provided between the 66-block and the fiber splice case/take-up spools. The backboard has been prepared with 4 screws to mount a 200 mechanics, 4-slot chassis. A standard 200 mechanics NTCE Mounting is available from Positron under model # 7200DT-04.

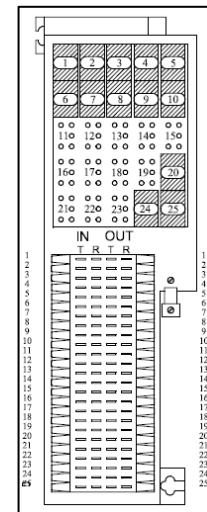

Fig. 2

If network span power is not available at the CFJ, bring -48Vdc power to the screws terminal terminals inside the Network Interface Chassis (aka NIU Housing).

1.5.4 Connect pairs from the “In” side of the 25-pair protector block to the **FAC** screw terminals of the NTCE Mounting (aka NIU Housing) per Figure 3 on page 4.

- 1.5.5** Connect pairs from the **CPE** screw terminals of the NTCE Mounting (aka NIU Housing) to the 66-block per the **laminated chart** located on the inside of the door panel of the cabinet, or as supplied with the backboard, per Figure 3, below.

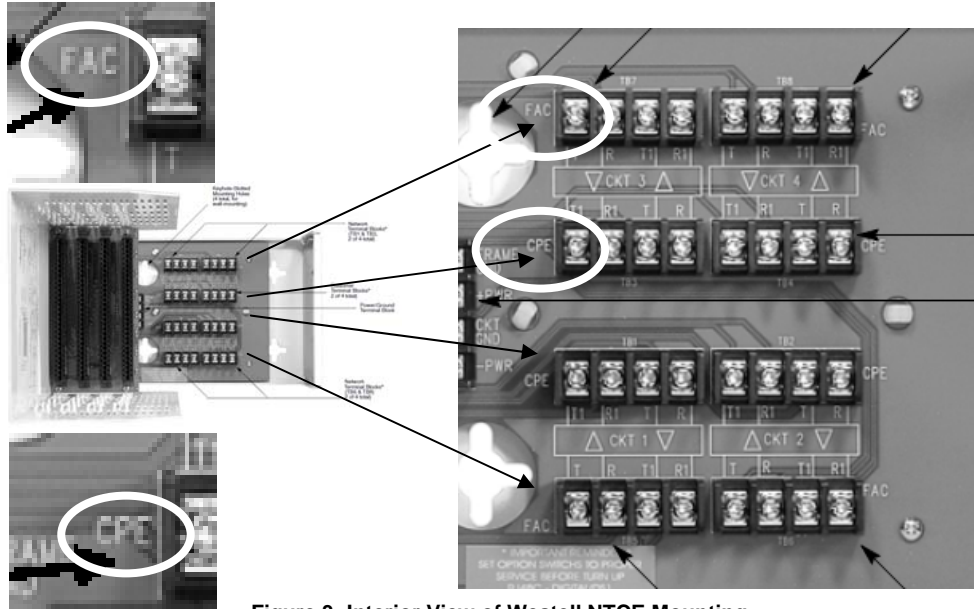

Figure 3: Interior View of Westell NTCE Mounting

- 1.5.6** Add bridging clips onto 66-block to connect input from the network to the CPE side of the 66-block. See Figure 4. The CPE (output) side of the 66-block feeds the TeleLite RJ Break-out array (Model #7250BB-50) affixed to the bottom-front of the TeleLite 6-slot shelf (Model #720000) via the Amphenol connector on the drop-side of the 66-block and associated cable.

NOTE: When used as an OEI at the Control House, the TX and RX copper pairs must be crossed at the 66-punch block for only T1 and DDS circuits.

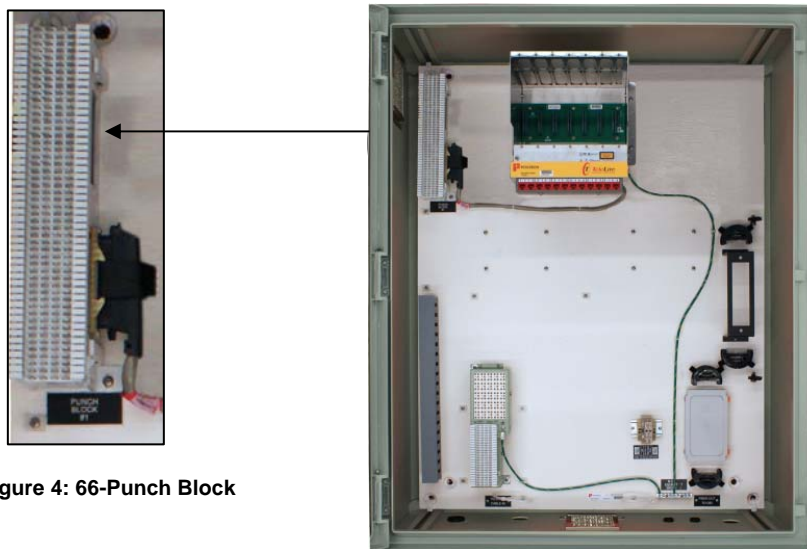

Figure 4: 66-Punch Block

724211/15

1.6 Installing Station Cable in the Optical Electrical Interface (OEI)

- 1.6.1** Connect copper pairs from the right-side of the 66-type punch block to the left, or “**In**” side of the 25-pair protector block per the **laminated chart** located on the inside of the door panel of the cabinet, or as supplied with the backboard.
- 1.6.2** Punch outgoing copper pairs of Station Cable of the OEI onto the right-hand side, or “**Out**”-side, of the 25-pair solid state protector block. See Figure 5. The “**Out**” side of the protector block always “points” to the world outside of the HVI, be it in the substation or in the PSTN. The pre-installed protector block is pre-connected to ground bar installed on the backboard. Refer to Section 1.2 for notes on grounding.
- 1.6.3** Equip the protector block with the solid state protectors as appropriate (Positron Model #'s 72505P-06 or 72505P-12, sold separately).
- 1.6.4** Add bridging clips onto 66-block to connect input from the CPE-side to the copper output of the TeleLite fiber modules. The TeleLite output side of the 66-block is fed from the TeleLite RJ Break-out array (Model #7250BB-50) affixed to the bottom-front of the TeleLite 6-slot shelf (Model #720000) via the Amphenol connector on the drop-side of the 66-block and associated cable.

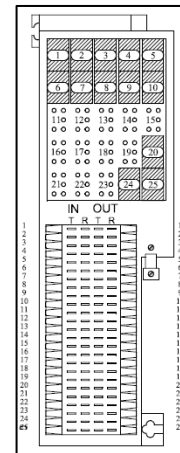

Figure 5

1.7 Optical Modules

Insert TeleLite optical modules into the appropriate shelf card-slot according to the RJ connector associated with the circuit, referring to laminated chart. For details on individual optical fiber TeleLite modules switch settings and LED indications, or for information on troubleshooting, please refer to the associated TeleLite fiber module User's Manual, shipped with each fiber module.

1.8 Copper Connections

Connect copper patch cords provided with each TeleLite fiber module between the faceplate RJ receptacles to the corresponding receptacle of the RJ Break-out array (Model # 7250BB-50) affixed to the bottom-front of the TeleLite 6-slot shelf. See Figure 6.



Figure 6: 7250BB-50 Break-Out Box installed on 720000 TeleLite Shelf

1.9 Fiber Connections

Connect incoming fibers (or fiber patch cords) to the TeleLite fiber module connectors.

NOTE:

- ✓ Incoming fibers to the TeleLite modules should be landed on the rear connector of the module (RX)
- ✓ Outgoing fibers from the TeleLite modules should be landed on the front connector of the module (TX)

2.0 TeleLite ZOI CFJ Cabinet Assemblies

List of TeleLite hybrid fiber assemblies covered in this section:

724200/15	40" x 32" TeleLite ZOI CFJ Cabinet Assembly with a single 6-slot shelf
724220/15	40" x 32" TeleLite ZOI CFJ Cabinet Assembly with dual 6-slot shelves

NOTE: This Model # 724200/15 polymer/fiberglass Cabinet Assembly (See Figure 7) is specially equipped for placement of the CFJ inside the ZOI of a substation. The treated, plywood backboard is painted red, is equipped with an array of red ADC Isolation Jacks, and has no provision for a local ground connection due to the inherent nature of the hazards associated with a CFJ placed within the ZOI of a substation.

This assembly should only be used as a CFJ within the ZOI.



Fig 7: 724200/15

2.1 Mounting

Mount the TeleLite ZOI CFJ Cabinet onto "H"-Frame or Pole-mount fixture. There is no ground bar provided with this assembly due to its intended location within the ZOI. **DO NOT** connect to a local ground. The model number for the pole-mount kit is 7550PK-30 for this ZOI CFJ assembly.

2.2 Grounding

2.2.1 ZOI CFJ:

This CFJ **cannot** be grounded due to safety considerations inside the ZOI, per IEEE-487-2014

2.2.2 OEI:

This assembly **cannot** be used as an OEI, per IEEE-487-2014

2.3 Fiber Installation

Feed incoming fiber cable to the cabinet assembly backboard.

- If splicing of pigtails to the incoming fiber cable is required, use the provided Channell fiber splice case located on the TeleLite backboard to house the splice, using the fiber take-up spools to wind the excess fiber.
- If a pre-connectorized fiber cable is used, patch cords may be required. In this case, mount a fiber patch panel (Positron Model #'s 7200FO-SM or 7200FO-MM) onto the metal bracket provided, using the fiber take-up spools to wind the excess fiber.

2.4 Copper Entrance Cable

Wire-wrap incoming copper TIP and RING pairs onto the right-hand side of the red, ADC high-voltage isolation jackfield per Figure 8, below.

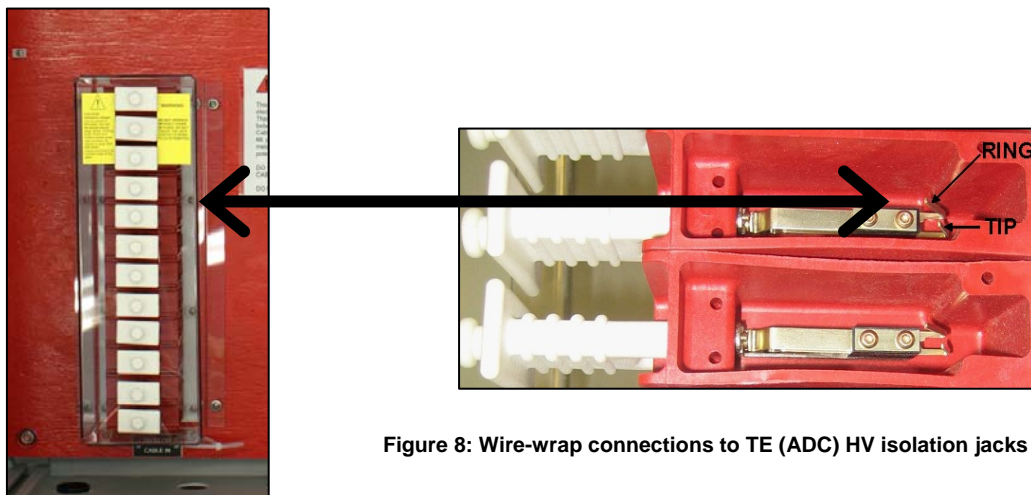

Figure 8: Wire-wrap connections to TE (ADC) HV isolation jacks

For HDSL service, an ADTRAN HxTU-R, or equivalent, is required. To house the HxTU-R, install the NCTE Mounting (aka NIU Housing) on the cabinet backboard on the four pre-installed screws located in the available space.

Connect pairs associated with the **FAC**-side of the NCTE Mounting from the left-side of the red ADC isolation jacks to the screw terminals of the **FAC**-side of the NCTE Mounting. See Figure 9.

Route the T1 signal from the output pairs of the CPE screw terminals of the NTCE Mounting to the right-side of the 66-block mounted on the assembly backboard per the **laminated chart** provided with the assembly.

If there is no NTCE required in the assembly, cross-connect the copper pairs from the left-side of the red ADC High-voltage isolation jacks to the 66-type punch block provided with the assembly.

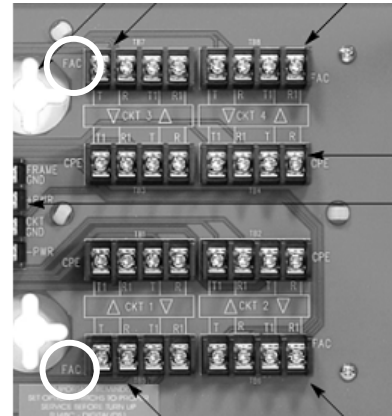

Fig 9: Interior view of NTCE Mounting

The 66-block is connected to the 6-slot TeleLite shelf via cabling terminated at the 66-type punch block in an Amphenol connector. See Figure 10.

Add bridging clips onto 66-block to connect input from the network to the output side of the 66-type punch block. The output side of the 66-type punch block feeds the TeleLite RJ Break-out array (Model #7250BB-50) affixed to the bottom-front of the TeleLite 6-slot shelf (Model #720000) via the Amphenol connector on the drop-side of the 66-block and associated cable.



Figure 10: 66-block

NOTE: When used as an OEI at the Control House, the TX and RX copper pairs must be crossed at the 66-punch block for only T1 and DDS circuits.

NOTE: Although the 724200/15 is ungrounded in the ZOI, the NIU Chassis and the TeleLite shelf should be bonded together using a #10 AWG ground conductor.

2.5 Optical Modules

Insert TeleLite optical modules into the appropriate shelf card-slot according to the RJ connector associated with the circuit, referring to laminated chart.

For details on individual optical fiber TeleLite modules switch settings and LED indications, or for information on troubleshooting, please refer to the associated TeleLite fiber module User's Manual, shipped with each fiber module.

2.6 Copper Connections

Connect copper patch cords provided with each TeleLite fiber module between the faceplate RJ receptacle and the corresponding receptacle of the RJ Break-out array (#7250BB-50) mounted on the TeleLite shelf (#720000), per Figure 11.



Fig 11: 7250BB-50 Break-Out Box installed on 720000 TeleLite Shelf

2.7 Fiber Connections

Connect incoming fibers (or fiber patch cords) to the TeleLite fiber module connectors.

NOTE:

- ✓ Incoming fibers to the TeleLite modules should be landed on the rear connector of the module (RX).
- ✓ Outgoing fibers from the TeleLite modules should be landed on the front connector of the module (TX).

3.0 TeleLite Assembly Layout Drawings

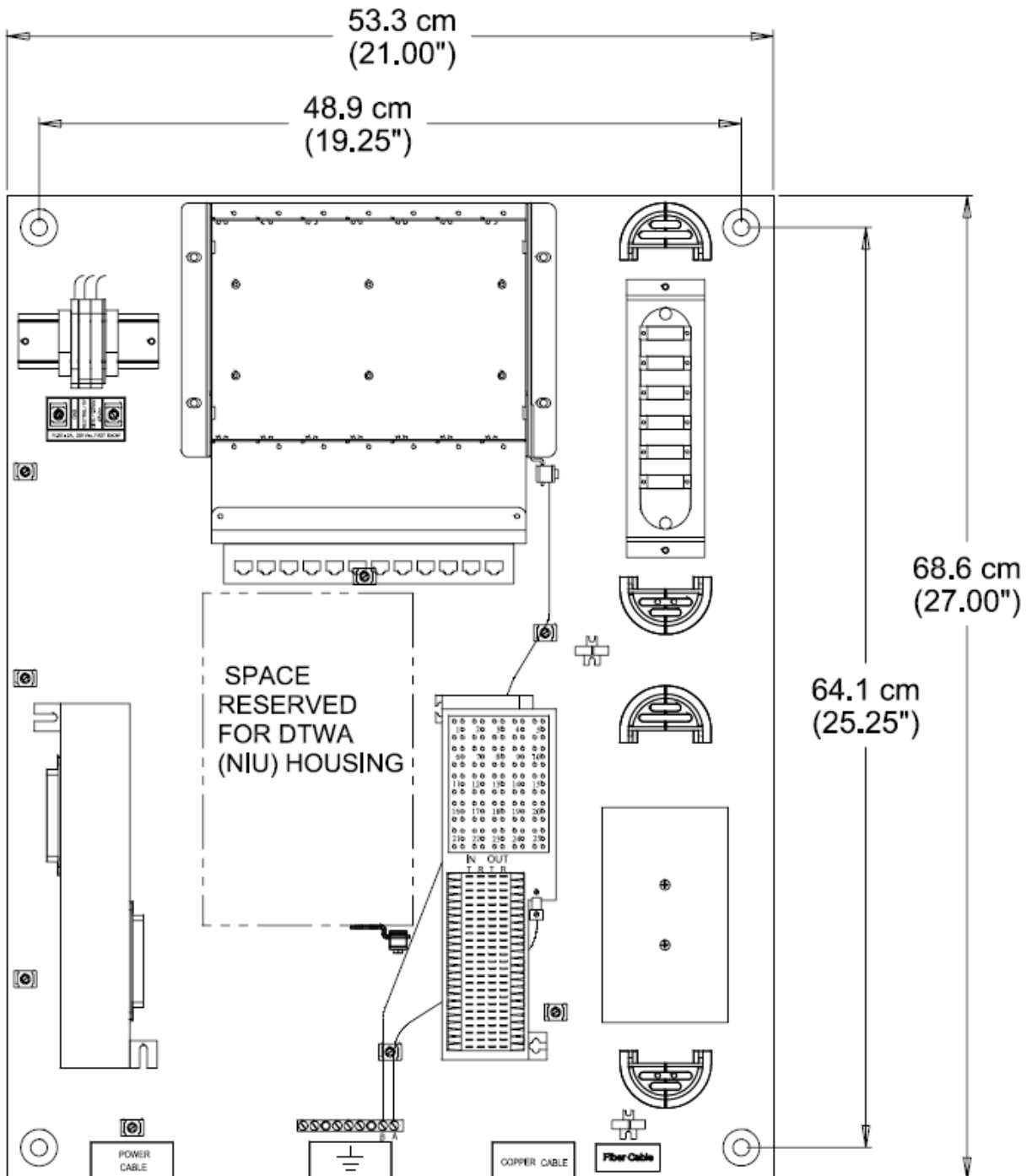

724201/05

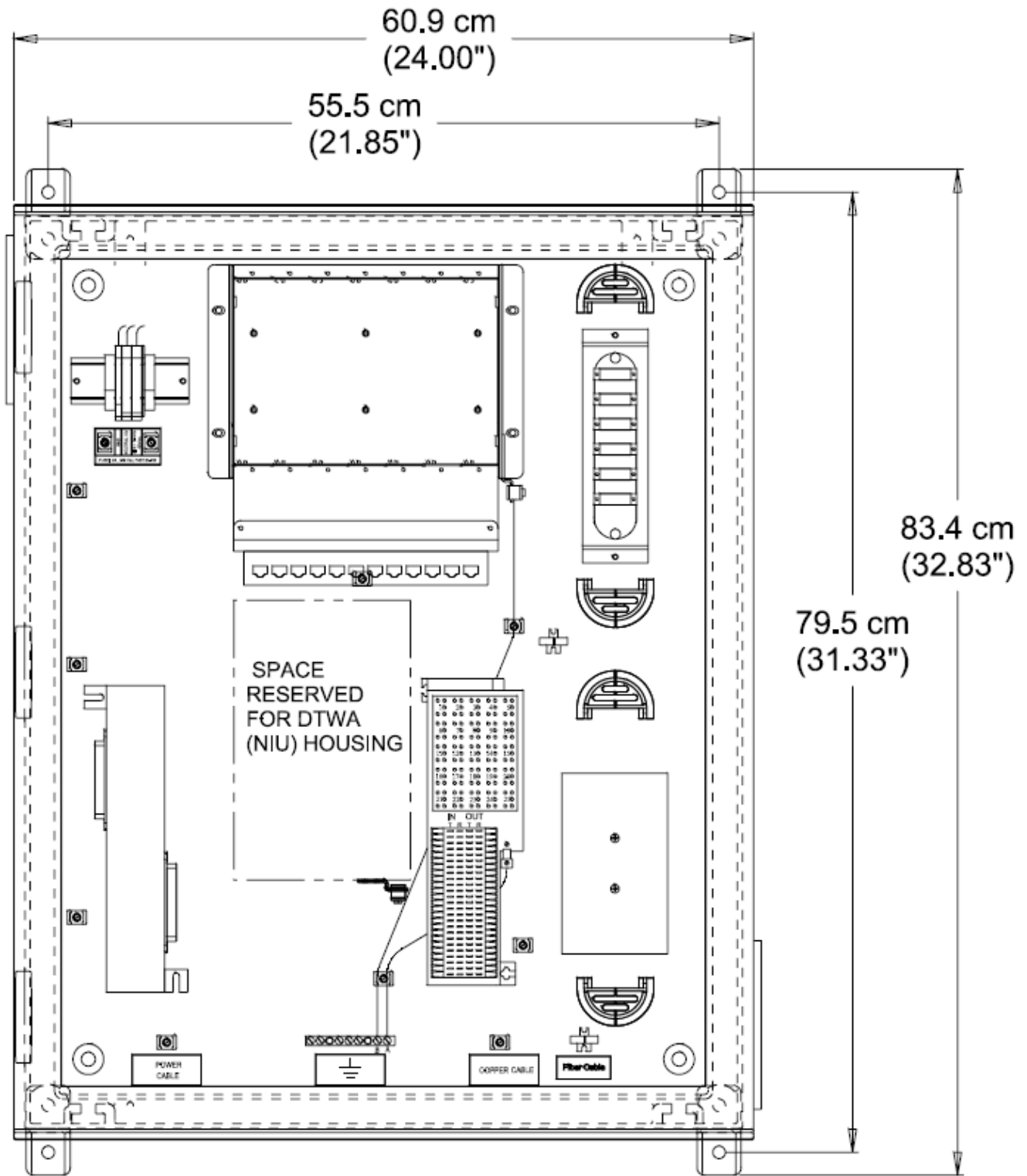

724201/15

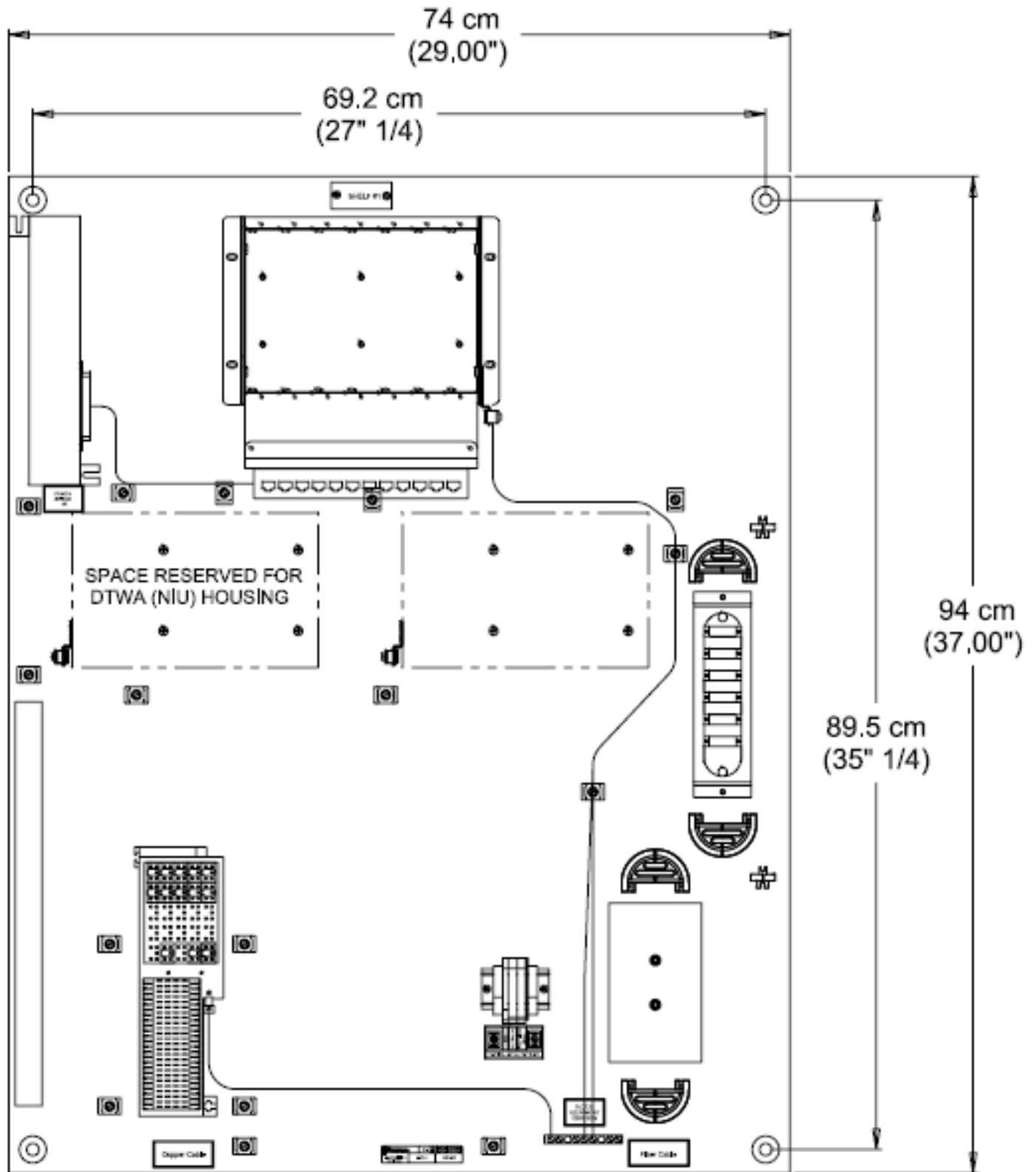

724211/05

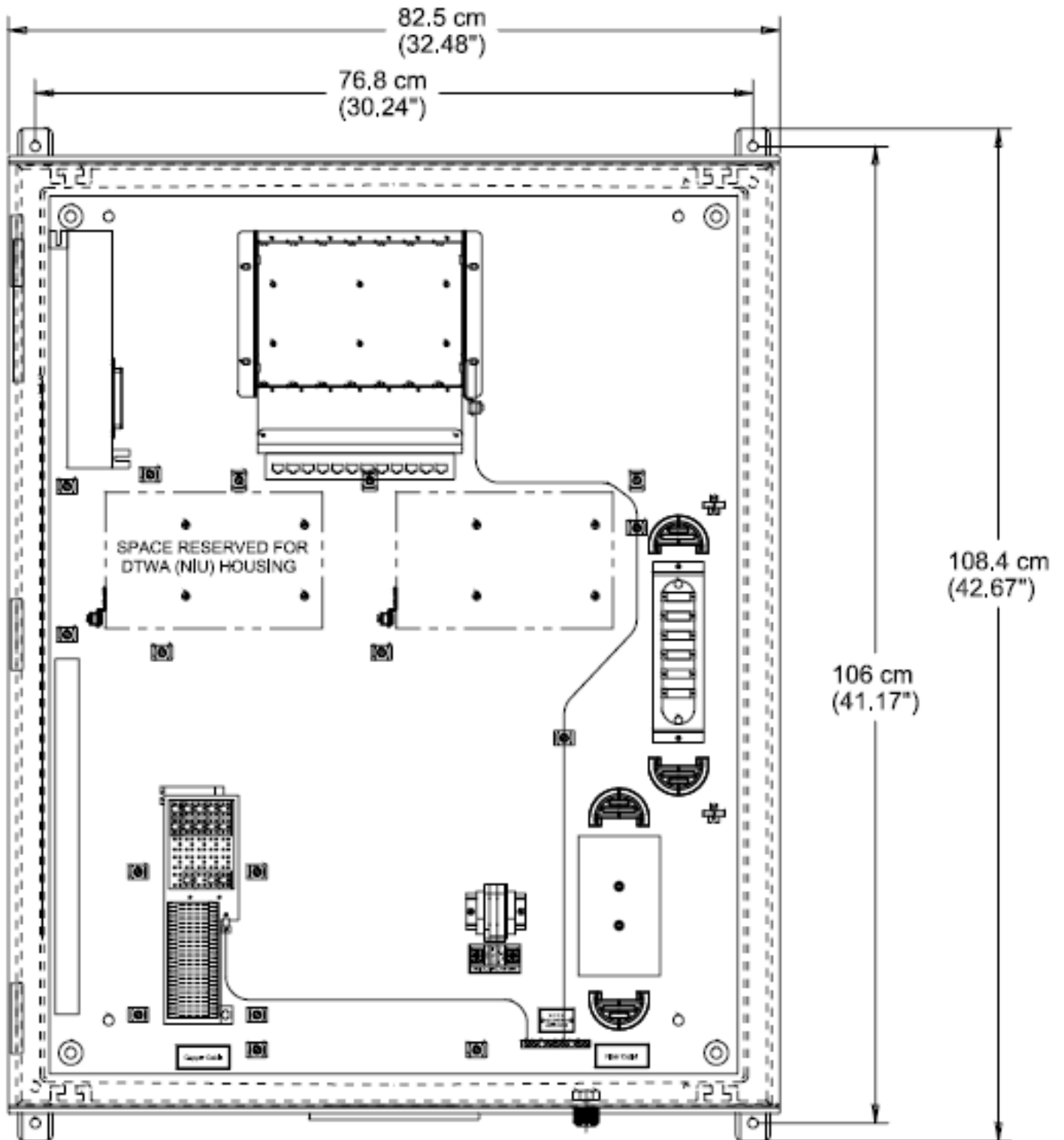

724211/15

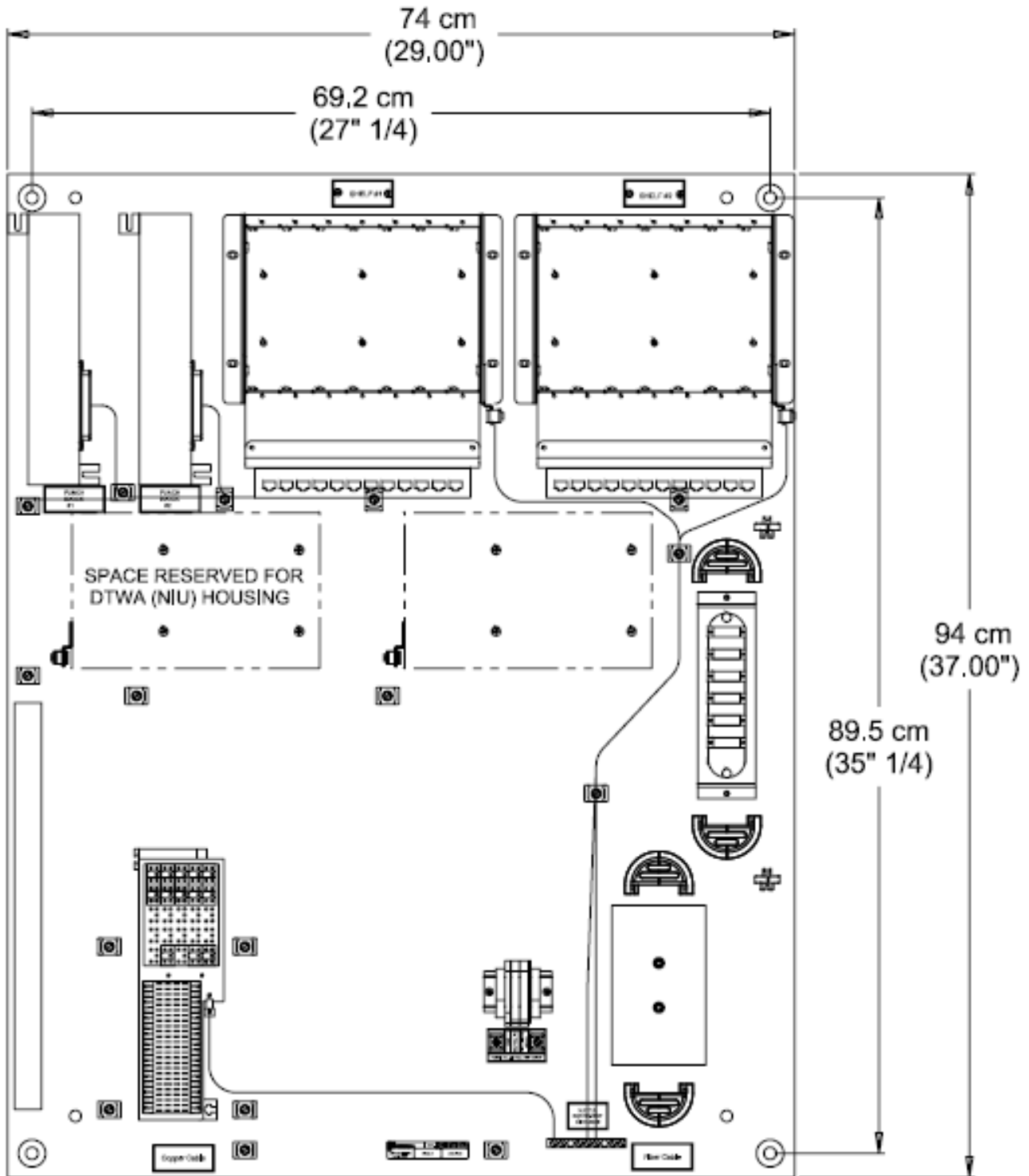

724221/05

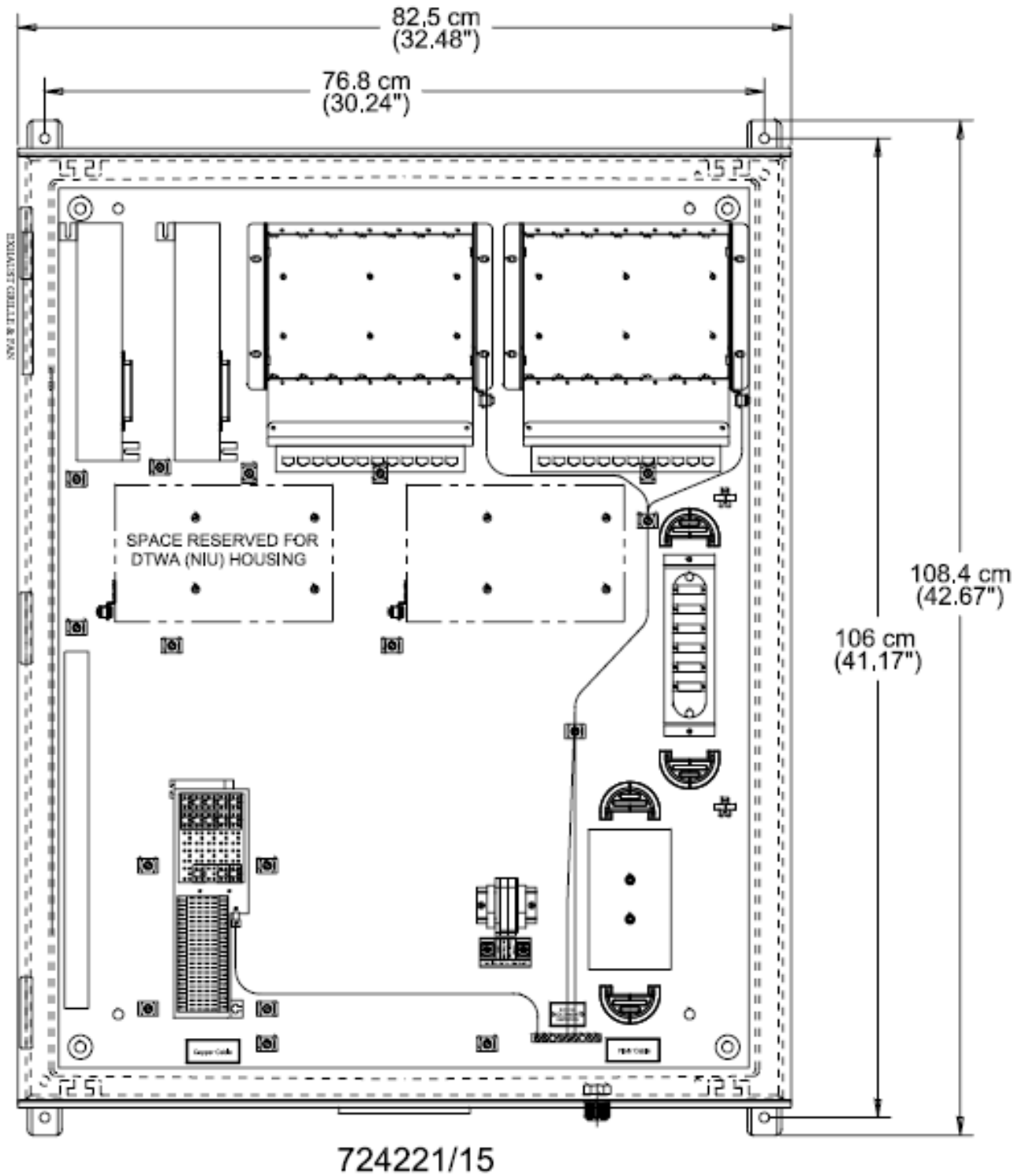

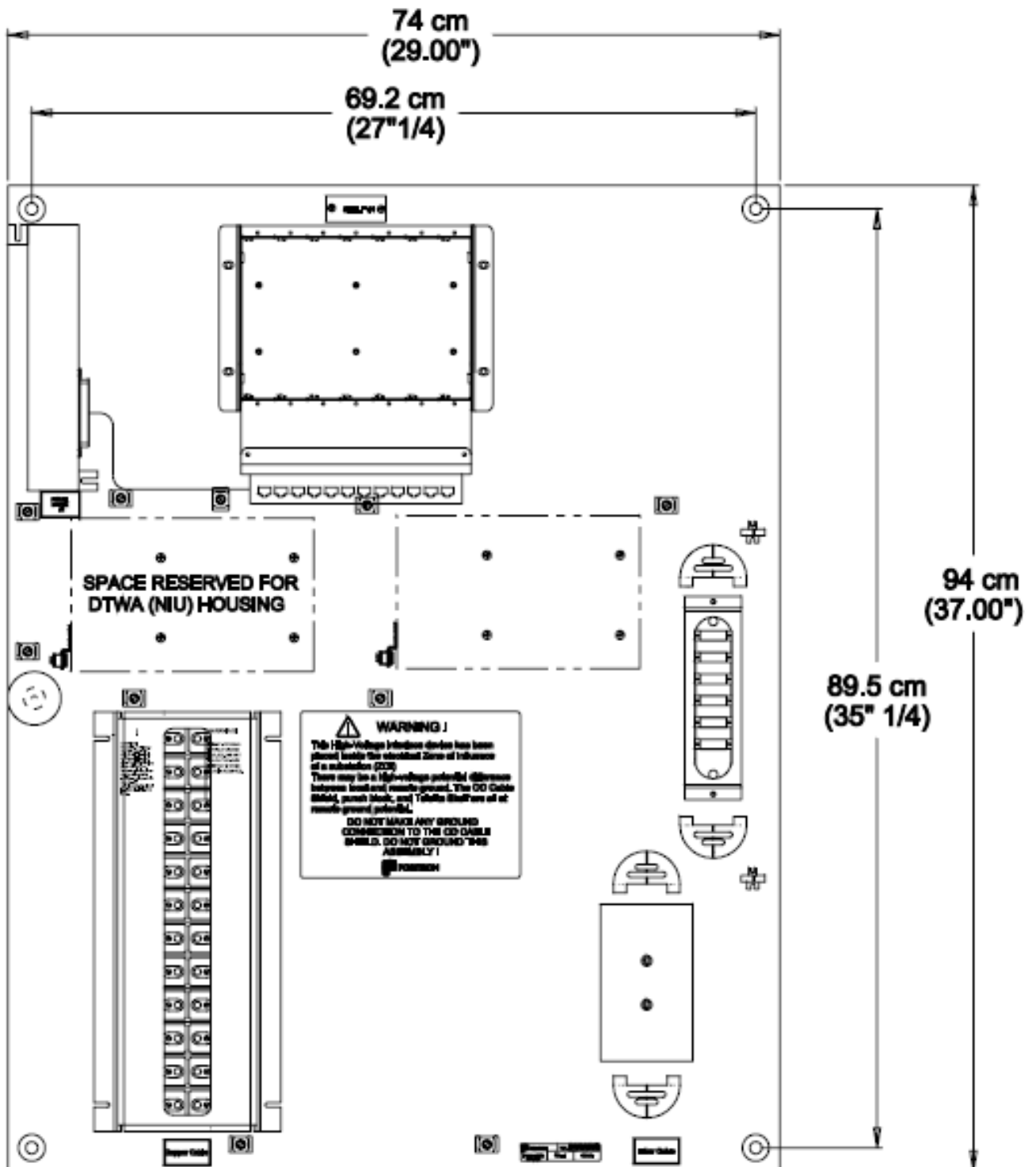

724200/05

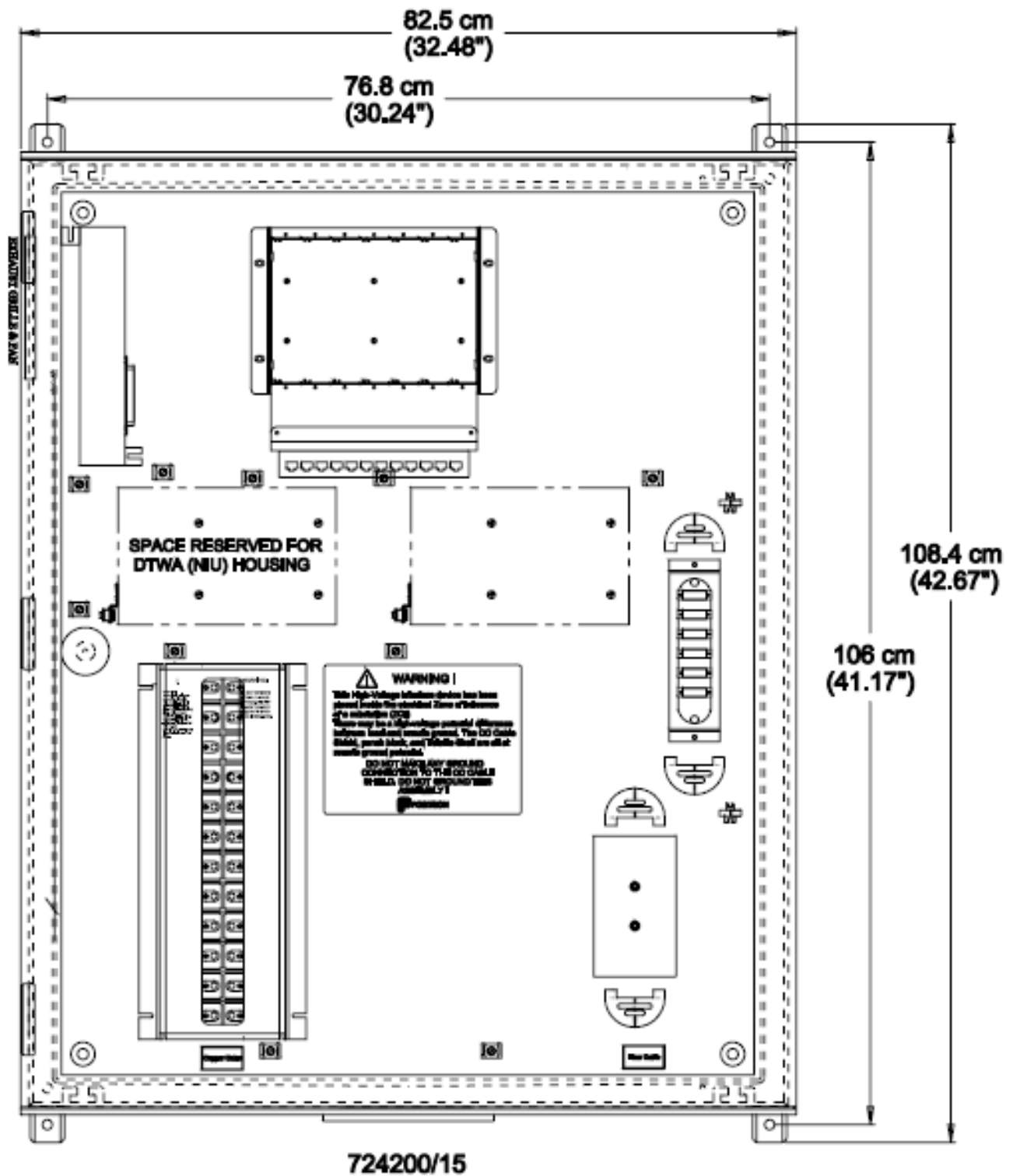

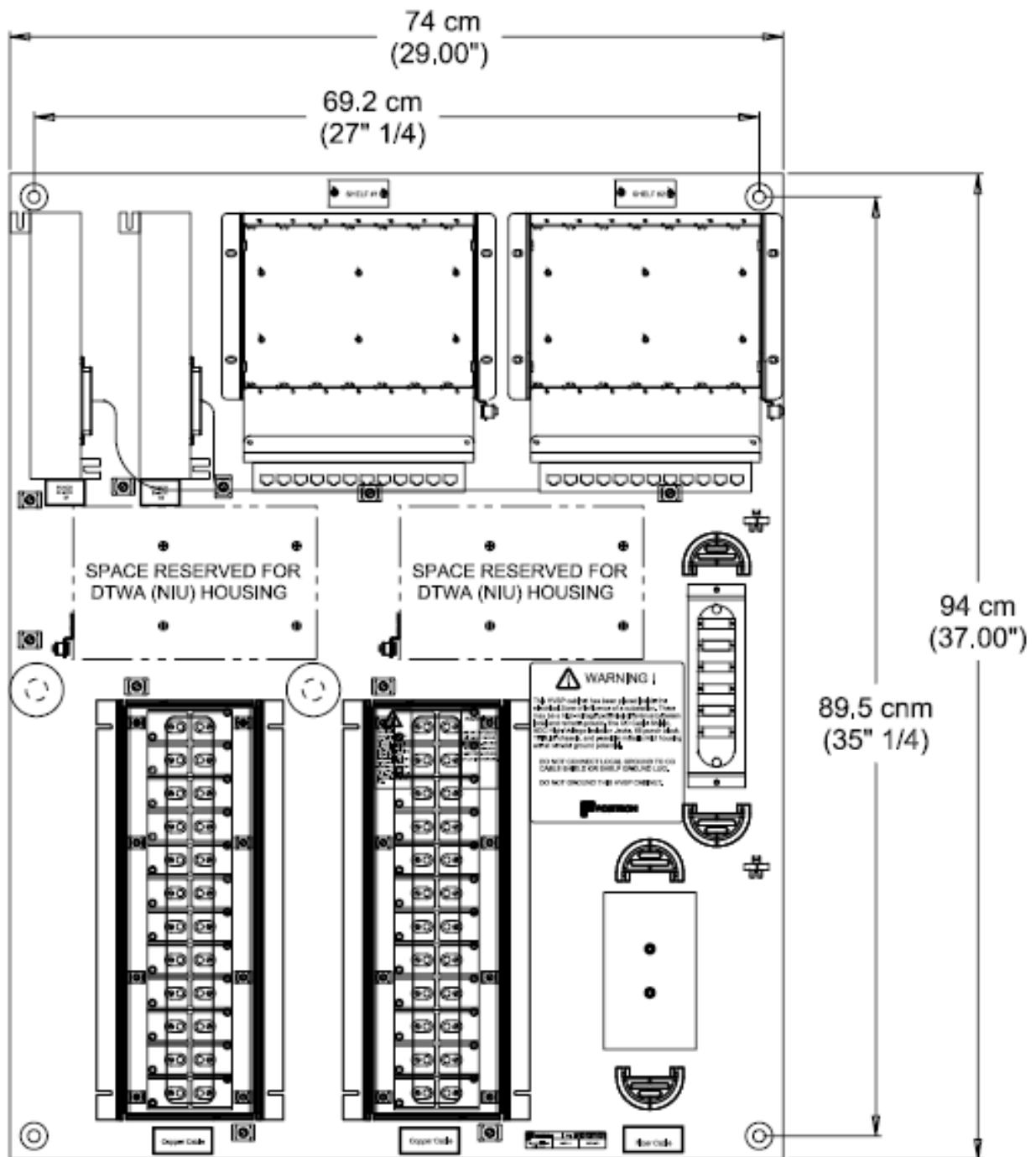

724220/05

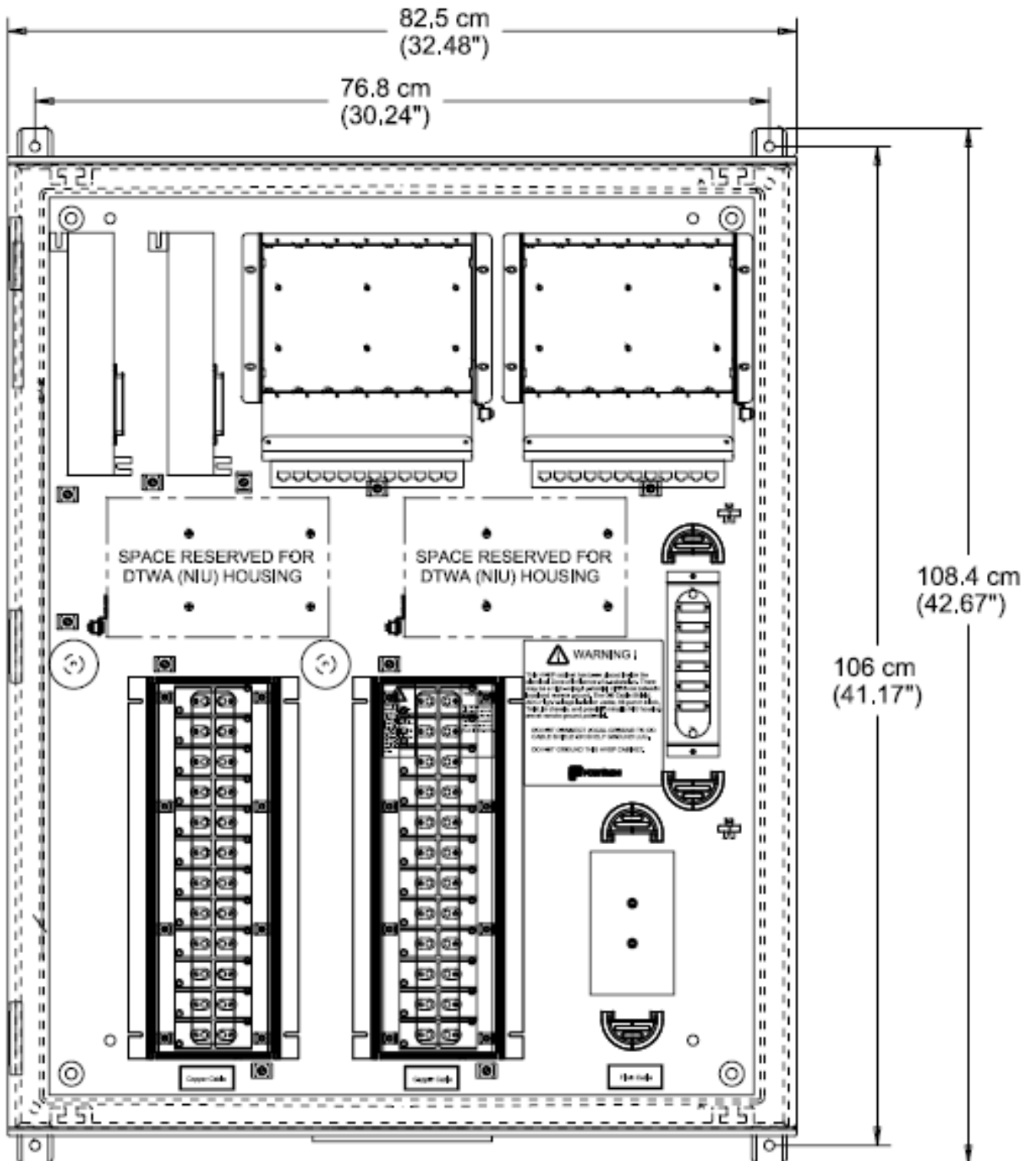

724220/15

4.0 Contact Information

Customer Support:

Toll-Free 1-888-577-5254, Option 9, 1

Technical Support:

Toll-Free 1-888-577-5254, Option 9, 3, 1

Sales Support:

Visit Positronpower.com, select “Contact Us” and select your region.

Publication Date: February 18, 2015
Document Number: 925W720120-01E